

SAMSUNG



High Resolution Vandal-proof Dome Camera SVD-4600 User Guide

Before installing and operating this product,
please read this manual thoroughly.

ENGLISH

Before operating the camera, confirm the camera model and proper input power voltage. In order to that you can understand this manual thoroughly, we'll introduce our model description.

■ SVD-4600 SERIES

- NTSC MODEL
SVD-4600(W)N
- PAL MODEL
SVD-4600(W)P

■ MODEL DESCRIPTION

- SVD-4600(W)X



- SIGNAL SYSTEM

N → NTSC MODEL
P → PAL MODEL

- CAMERA COLOR

→ SILVER COLOR
W → IVORY COLOR

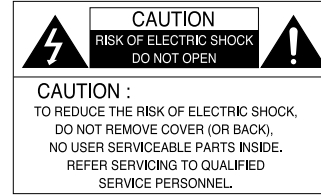

The lightning flash with an arrowhead symbol, within an equilateral triangle is intended to alert the user to the presence of uninsulated “dangerous voltage” within the product’s enclosure that may be of sufficient magnitude to constitute a risk of electric shock to persons.



The exclamation point within an equilateral triangle is intended to alert the user to the presence of important operating and maintenance (servicing) instructions in the literature accompanying the appliance.

INFORMATION-This equipment has been tested and found to comply with limits for a Class A digital device, pursuant to part 15 of the FCC Rules. These limits are designed to provide reasonable protection against harmful interference when the equipment is operated in a commercial environment. This equipment generates, uses, and can radiate radio frequency energy and, if not installed and used in accordance with the instruction manual, may cause harmful interference to radio communications.

Operation of this equipment in a residential area is likely to cause harmful interference in which case the user will be required to correct the interference at his own expense.

WARNING -Changes or modifications not expressly approved by the manufacturer could void the user’s authority to operate the equipment.

WARNING -To prevent electric shock and risk of fire hazards:

- ◆ Do NOT use power sources other than that specified.
- ◆ Do NOT expose this appliance to rain or moisture.

This installation should be made by a qualified service person and should conform to all local codes.

- Precautions 7
- Components and Accessories 9
- Overview 9
- Connection 10
 - Connecting To Monitor 10
 - Connecting To Power 11
 - RS-485 communication control 12
- Operating Your Camera 13
 - Menu Configuration 13
 - Menu Setup 13
 - LENS 14
 - EXPOSURE 15
 - WHITE BALANCE 16
 - BACKLIGHT 18
 - SSNR 20
 - DAY/NIGHT 21
 - IMAGE ADJ 22
 - SPECIAL 24
 - EXIT 28
- Troubleshooting 29
- Specification 30
- Dimension 30

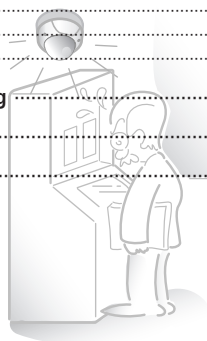

Ultra High Resolution

By adopting a double-speed 410,000 pixel Sony CCD, the camera produces clear picture quality with a horizontal resolution of 560 TV lines for color and 700 TV lines for B/W.



Vari-focal Lens Built-in

With built-in vari-focal lens, the camera can control the focal distance easily from 2.8 to 10.0mm.



Wide Dynamic Range (WDR):

By adopting a proprietary SV-IV DSP chip, the camera delivers clear, high quality pictures even in backlight, by increasing exposure in dark areas while decreasing it in bright areas; a corrected image with clear details results.



Excellent Sensitivity

Adopting a Diagonal 6mm (1/3"), highly sensitive CCD and digital signal processing technology, it can clearly distinguish the outline and color of a subject in an extremely low luminance environment – even, for example, under starlight. Since surveillance is possible in places where the light is poor, the camera is appropriate for day and night surveillance outdoors or on the outside of buildings.
- 0.00004 Lux



SSNR (Samsung Super Noise Reduction) Function

The high performance SV-IV DSP chip dramatically reduces the gain noise in digital image processing, producing clear, sharp images in low lighting environments.



Day & Night

The camera identifies whether it is day or night and automatically switches to the appropriate mode, depending on its environment. By day, the camera switches to color mode in order to maintain optimal color. At night, it switches to B/W mode so as to obtain better picture definition.



DIS (Digital Image Stabilizer)

The DIS function compensates for any camera movement, to produce more stable pictures.



Sub Monitor Function

The sub monitor function enables easy adjustment of the camera angle within the monitoring range during its installation.



IP66 Approved / Dust & Rain Resistant

With dust and rain resistant design, the camera can be installed outside under building eaves or place that is exposed to the dust and rain.



Miscellaneous Functions

SYNC(INT/L), SENS-UP, FREEZE, FLIP(H/V-REV), 0-ZOOM, SHARPNESS, MOTION DETECTION and PRIVACY functions are provided.



RS-485 Communication Control Support

Remote OSD menu control via an RS-485 interface is supported.



OSD

The camera control is convenient by using 9 different foreign language O.S.D.

- NTSC : Korean, English, Spanish, Japanese, French, Portuguese
- PAL : English, French, German, Spanish, Italian, Chinese, Portuguese

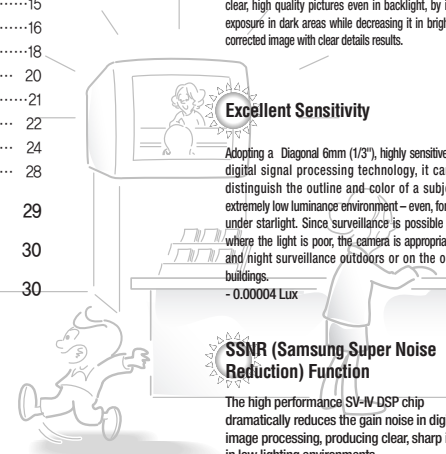



Samsung Techwin cares for the environment at all product manufacturing stages to preserve the environment, and is taking a number of steps to provide customers with more environment-friendly products. The Eco mark represents Samsung Techwin's will to create environment-friendly products, and indicates that the product satisfies the EU RoHS Directive.

Warnings & Cautions

This information is provided to ensure your safety and to prevent any losses, financial or otherwise. Please read it carefully and use the product accordingly.

- * For product inquiries, please contact the retail shop where you bought the camera. The use of equipment such as an aerial ladder while providing after-sales service shall be at your expense.
- * Separate the power plug when thunder crashes or lightning flashes.
- * This product is support equipment for surveillance system. Therefore, we can't compensate for material loss and/or personal injuries by robbery, fire, natural disaster or something like this type.

Warning/Attention/Special Mark Messages



Ignoring this information may result in material loss and/or serious personal injuries including death.



Ignoring this information may result in material loss and/or a slight injuries.



Indicates "Never Allowed."



Indicates "No Disassembling."



Correct Disposal of This Product (Waste Electrical & Electronic Equipment)

(Applicable in the European Union and other European countries with separate collection systems)

This marking shown on the product or its literature, indicates that it should not be disposed with other household wastes at the end of its working life. To prevent possible harm to the environment or human health from uncontrolled waste disposal, please separate this from other types of wastes and recycle it responsibly to promote the sustainable reuse of material resources.

Household users should contact either the retailer where they purchased this product, or their local government office, for details of where and how they can take this item for environmentally safe recycling.

Business users should contact their supplier and check the terms and conditions of the purchase contract. This product should not be mixed with other commercial wastes for disposal.

Precautions

Do not install the camera in extreme temperature conditions.



Only use the camera under conditions where temperatures are between -10°C and $+50^{\circ}\text{C}$. Be especially careful to provide ventilation when operating under high temperatures.

Do not install or use the camera in an environment where the humidity is high.



It can cause the image quality to be poor.

Do not install the camera under unstable lighting conditions.

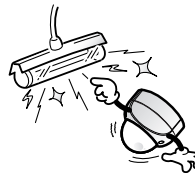

Severe lighting change or flicker can cause the camera to work improperly.

Do not touch the front lens of the camera.



It is one of the most important parts of the camera. Be careful not to be stained by fingerprint.

Precautions

Do not drop the camera or subject them to physical shocks.



It can cause malfunctions to occur.

Never keep the camera face to strong light directly.

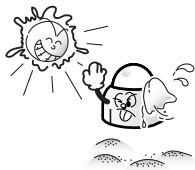

It can damage the CCD.

Do not expose the camera to radioactivity.



If it is exposed to radioactivity, For heated CCD, it will be out of order.

Notes

- If the camera is exposed to spotlight or object reflecting strong light, smear or blooming may occur.
- Please check that the power satisfies the normal specification before connecting the camera.

Components and Accessories

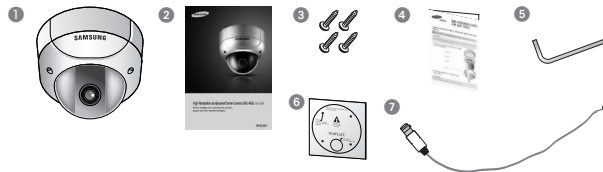

- 1 SVD-4600
2 Instruction Manual
3 M5 Tapping Screw 4EA
4 Quick Install Guide
5 Wrench
6 Template
7 Installation Video Output Cable

Overview

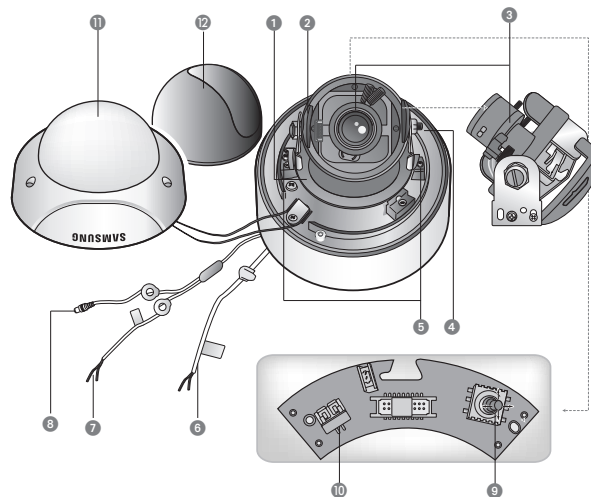

Overview

- 1 Pan Base : control panning angle of camera
- 2 Rotate Base : control rotating angle of camera
- 3 X3.6 Vari-focal Lens Module
- 4 Rotate Base Holding Screw : fix rotated position
- 5 Pan Base Holding Screws (Color : Silver) : fix panned position
- 6 RS-485 Control Cable : The detailed description refers to p12
- 7 Power Input Jack
- 8 Video Output Jack
- 9 Function Setup switch : display the menu on the screen and move the cursor to four directions to confirm status or after changing a selected item.
- 10 Video Output Terminal to Monitor
- 11 Dome Cover
- 12 Shield Case

Connection

Connecting to Monitor

Connect the VIDEO-OUT jack to the VIDEO-IN jack of monitor.

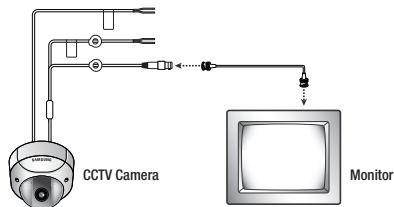

- As the connecting method varies with the instruments, refer to the manual supplied with the instrument.
- If necessary, you can connect the monitor to the REMOTE jack on the back of your camera.
- Only connect the cable when the power is turned off.
- Set the 75Ω / Hi-Z selection switch as shown below if you have an intermediate device.

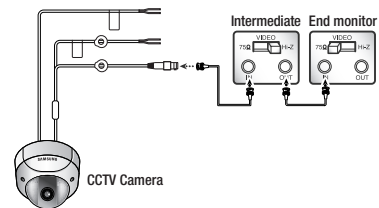

Connecting to Power

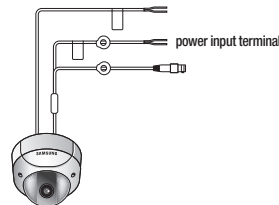

Connect the adaptor to the power input connector as shown in the figure below. The recommended adaptor specification for SVD-4600 is AC 24V / 500mA or DC 12V / 500mA.

When the resistance value of copper wire is at [20°C(68°F)]

Copper wire size (AWG)	#24(0.22mm ²)	#22(0.33mm ²)	#20(0.52mm ²)	#18(0.83mm ²)
Resistance (Ω / m)	0.078	0.050	0.030	0.018
Voltage Drop (V/m)	0.078	0.018	0.011	0.006

- As shown in the table above, voltage decreases as the wire gets longer. Therefore use of an excessively long adaptor output line for connection to the camera may affect the performance of the camera.

*Standard voltage for camera operation : DC 12V ± 10%, AC 24V±10%

*There may be some deviation in voltage drop depending on the type of wire and the manufacturer.



Notes

- Be sure to connect power only after all the installation is complete.
- Use the UL listed, class 2 power transformer of AC 24V adaptor.
- Ground should be connected to the GND terminal.

Connection

RS-485 communication control

Connecting to RS-485 Control Cable

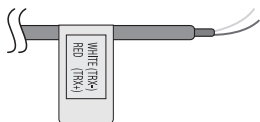

CONTROL CABLE	SPEC
RED (TRX+)	RS-485+
WHITE (TRX-)	RS-485-

Using a RS-485 communication, it will be able to control the OSD menu at the SAMSUNG TECHWIN System Controller or DVR.

(1) The case which it controls from the PC

Using a RS-485 converter, It connects to RS-485 control cable outside camera and serial cable

EX) SERIAL PORT OF THE PC(COM1) → SERIAL CABLE → RS-485 CONVERTER → RS-485 CONTROL CABLE

(2) The case which it controls from the DVR or System Controller

It connects the RS-485 control cable in the connection terminal of 485 control boards which are connected with the DVR or System Controller.

485 Control Board Connection Port	RS-485 Control Port
(+) CONNECTION TERMINAL	RED (TRX+)
(-) CONNECTION TERMINAL	WHITE (TRX-)

* RS-485 Communication establishment initial value

Item	Camera ID	BAUD RATE	UART MODE	RET PKT
Initial value	1	9600	8-NONE-1	ENABLE



Notes

- When you construct external control systems for a camera control, please use to the SAMSUNG TECHWIN PROTOCOL or PELCO-D PROTOCOL.
- When you connecting to RS-485 control cable, please peel off the outer skin inside the RS-485 control cable.
- In case of SCC-101 connection, change communication mode to '8-E-1' at 'Communication configuration' menu. (For more information, refer to SCC-101 manual.)

Operating Your Camera

Menu Configuration

Setup Menu			
LENS	●DC		
EXPOSURE	●SHUTTER	●AGC	●SENS-UP
	●RETURN		
WHITE BALANCE	●ATW	●MANUAL	●AWC→SET
	●OUTDOOR	●INDOOR	
BACKLIGHT	●OFF	●WDR	●BLC
	●HLC		
SSNR	●ON	●OFF	
DAY/NIGHT	●COLOR	●B/W	●AUTO
IMAGE ADJUSTMENT (IMAGE ADJ.)	●FREEZE	●V-REV	●H-REV
	●D-ZOOM	●SHARPNESS	●RETURN
SPECIAL	●CAMTITLE	●SYNC	●MOTION DET
	●PRIVACY	●DIS	●COMM ADJ
	●LANGUAGE	●RESET	●RETURN
EXIT			

Menu Setup

Use the Function Setup switch on back of the camera.

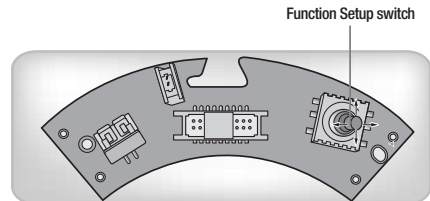

Operating Your Camera

1. Press the Function Setup switch.

- Main setup menu is displayed on the monitor screen.

Select the function by moving up or down direction of function setup switch.

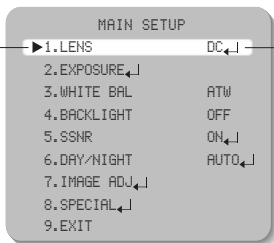

Change the status by moving right or left direction of function setup switch.

2. Select a desired function using the Function Setup switch.

- Place the cursor over a desired item.

3. Set up a selected item by using the Function Setup switch.

4. To finish the setting, select 'EXIT' and press the Function Setup switch.



Notes

- An item with the ↵ icon also has sub menus. To select a sub menu, select an item with the icon and press the Function Setup switch.
- An item with the --- icon is unavailable due to function settings.

LENS

Using this function, you can control screen brightness.

1. When the SETUP menu screen is displayed, select 'LENS' by using the Function Setup switch so that the arrow indicates 'LENS'.

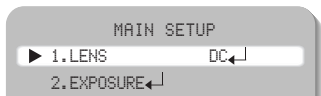

⇒ DC : Select Auto Iris Lens

- When DC is selected, you can control screen brightness. The range of brightness control is between 1 and 70. Adjust the brightness appropriately for optimal screen brightness.



EXPOSURE

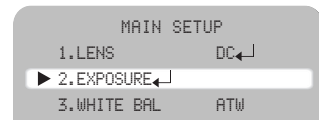

1. When the SETUP menu screen is displayed, select 'EXPOSURE' by using the Function Setup switch so that the arrow indicates 'EXPOSURE'.

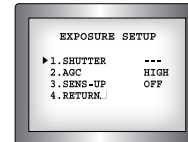

2. Select a desired mode using the Function Setup switch.

- ⇒ SHUTTER : Because of using a DC lens, the shutter speed is fixed. (NTSC mode I: 1/60 sec, PAL model : 1/50 sec)

When flickering occurs on the screen, select the A.FLK mode using the Function Setup switch.

- A.FLK : Select this when you experience picture flicker, which can happen when there is a dash with the frequency of the installed lighting.



Notes

- To produce better results with A.FLK, do not use it in conjunction with the WDR mode of the BACKLIGHT menu.
- When the SHUTTER is set to A.FLK mode, SENS-UP will be disabled.

Operating Your Camera

AGC (AUTO GAIN CONTROL) :

The higher the gain level, the brighter the screen - but the higher the noise.

- OFF : Deactivates the AGC function.
- LOW : Allows automatic gain control from 5.3dB to 30dB.
- HIGH : Allows automatic gain control from 5.3dB to 42dB.

SENS-UP :

When it is night or dark, the camera automatically detects the light level and maintains a clear picture if this mode is activated.

- OFF : Deactivates the SENS-UP function.
- AUTO : Activates the SENS-UP function.



RETURN :

Select this to save the changes in the EXPOSURE menu and return to the SETUP menu.

Notes

- If you press the Function Setup switch in 'AUTO' mode, You can adjust brightness by increasing or decreasing the shutter speed. (x2 ~ x256)
- Note that the higher the zoom level, the brighter the screen, but the more likely it is that an after-image will appear.
- Although Noise, Spots, and Whitish symptoms may occur in SENS-UP operation when the zoom level is increased, this is normal.

White Balance (White Bal.)

Use the White Balance function to adjust the screen color.

1. When the SETUP menu screen is displayed, select 'White Bal.' by using the Function Setup switch so that the arrow indicates 'White Bal.' .
2. Select a desired mode using the Function Setup switch.

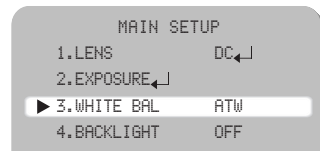

* Select one of the following 5 modes, as appropriate for your purpose.

- ▶ ATW : Select this when the color temperature is between 1,800°K and 10,500°K
- ▶ INDOOR : Select this when the color temperature is between 4,500°K and 8,500°K.
- ▶ OUTDOOR : Select this when the color temperature is between 1,800°K and 10,500°K. (sodium light inclusion)
- ▶ AWC → SET : To find the optimal setting for the current luminance environment in this mode, set the point the camera towards a sheet of white paper and press the Function Setup switch. If the environment changes, readjust it.
- ▶ MANUAL : Select this to fine-tune White Balance manually. Set White Balance first by using the ATW or AWC mode. After that switch to MANUAL mode, fine-tune the White Balance and then press the Function Setup switch.

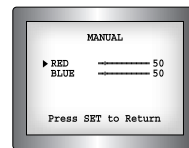

Notes

- White Balance may not work properly under the following conditions. In this case select the AWC mode.
 - ① When the color temperature of environment surrounding the subject is out of the control range (e.g. clear sky, or sunset)
 - ② When the ambient illumination of the subject is dim.
 - ③ If the camera is directed towards a fluorescent light or is installed in a place where illumination changes dramatically, the White Balance operation may become unstable.

Operating Your Camera

BACKLIGHT

This camera is designed so that it delivers a distinctive subject and background at the same time, even when the subject is in backlight, unlike conventional cameras, by adopting a proprietary SV-IV DSP chip.

1. When the SETUP menu screen is displayed, select 'BACKLIGHT' by using the Function Setup switch so that the arrow indicates 'BACKLIGHT'.
2. Select a desired mode using the Function Setup switch depending on the camera purpose.

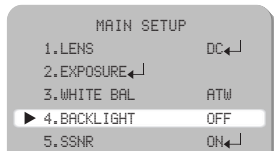

- BLC : Enables a user to directly select a desired area from a picture, and to view the area more clearly.
 - Select 'BLC' to adjust the area to be enhanced and enhancement level.
- WDR : When there are both bright and dark areas at the same time, this mode makes both areas distinctive.



WDR



OFF

- Select 'WDR' to adjust the WDR LIMIT and LEVEL.
 - LIMIT : Adjust the WDR Sensitivity by selecting LOW, MIDDLE, or HIGH.
 - LEVEL : Adjust the WDR Brightness by controlling the bar from 1 to 100.



- The WDR compensates for backlight more effectively than previous models, by applying an optimum fusion ratio when combining the high speed shutter used in bright areas and the low speed shutter used in dark areas.

- HLC(High Light Compensation) :
If the scene contains extremely bright light areas such as; from car headlight, the light can mask out much of the on-screen detail.
 - DAY : in normal daylight conditions, the HLC is not activated.
 - NIGHT : If a high light that is larger than a certain size is present on the screen, HLC is activated to remove the high light.
 - HLC : Enable a user to select a mask color of high light area from a picture.



- OFF : Not being used.
3. Select a desired mode using the Function Setup switch and press the SET button.

Notes

- Since the following symptoms may occur according to the ambient illumination when WDR is selected, set it to OFF.
 - ① Color or screen changes unnaturally.
 - ② Noise appears in the bright part of the screen.
- Since the performance of the WDR function may be affected by the area of the bright part of the screen, optimize the installation angle for the best WDR performance.
- If you increase LIMIT, the screen display may be distorted.
- In a dark environment, the HLC is only activated when a high light that is larger than a certain area is present.
- The HLC is not activated in light or overly dark conditions.

Operating Your Camera

SSNR

This function reduces the background noise in a low luminance environment.

1. When the SETUP menu screen is displayed, select 'SSNR' by using the Function Setup switch so that the arrow indicates 'SSNR'.

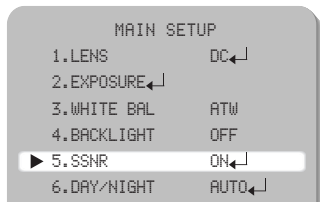

2. Select a desired mode using the Function Setup switch.

- OFF : Deactivates SSNR. Noise is not reduced.
- ON : Activates SSNR so that noise is reduced.

3. Set the SSNR mode to 'ON' and press the Function Setup switch. Then you can adjust the noise reduction level.



Notes

- You cannot set the SSNR to 'ON' or 'OFF' when the AGC mode of the EXPOSURE menu is 'OFF'.
- When adjusting the noise reduction level of the SSNR mode, remember that the higher the level set, the more the noise level will be reduced but that after image may also occur.

DAY/NIGHT

You can display pictures in color or black and white.

1. When the SETUP menu screen is displayed, select 'DAY/NIGHT' by using the Function Setup switch so that the arrow indicates 'DAY/NIGHT'.

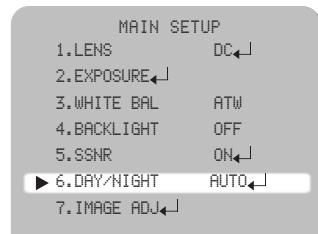

2. Select a desired mode using the Function Setup switch according to the picture display you want.

- COLOR : The picture is always displayed in color.
- B/W : The picture is always displayed in black and white. Please press SETUP button to turn on or off the burst signal on B/W mode.
- AUTO : The mode is switched to 'Color' in a normal environment, but switches to 'B/W' mode when ambient illumination is low. To set up the switching time or speed for AUTO mode, press the Function Setup switch.

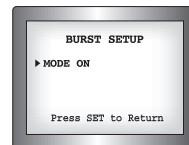

- DWELL TIME : You can select the duration time about changing the day/night mode.
→ 5s, 7s, 10s, 15s, 20s, 30s, 40s, 60s



- DURATION : You can select brightness of illumination about changing the day/night mode.

Operating Your Camera

	Color → B/W	B/W → Color
Fast	2.5 lux	4 lux
Slow	0.8 lux	6 lux

* The brightness of illumination is changeable by installed environment.

○ EXTERN : This mode allows you to apply a desired filter to external signals.

Notes

- You cannot control the DAY/NIGHT menu when AGC in the EXPOSURE menu is 'OFF'. At this time, the exchange between DAY mode and NIGHT mode operates as like selecting 'COLOR' mode.
- The OSD key does not work for 3 seconds when switching to Color or B/W, to ensure stable camera operation.
- The camera may focus less well under infrared illumination than under normal illumination.

IMAGE ADJ.

1. When the SETUP menu screen is displayed, select 'IMAGE ADJ.' by using the Function Setup switch so that the arrow indicates 'IMAGE ADJ.'

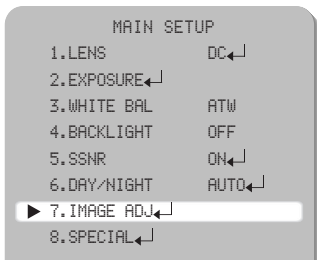

2. Select a desired mode using the Function Setup switch.

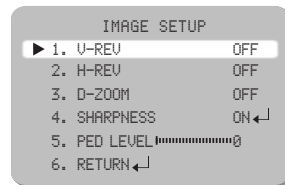

- FREEZE : You can view still or moving pictures.
- V-REV : You can flip the picture vertically on the screen.
- H-REV : You can flip the picture horizontally on the screen.
- D-ZOOM : You can use a digital zoom of x2~x10.

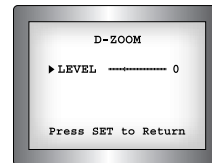

○ SHARPNESS :

As you increase this value, the picture outline becomes stronger and clearer. Adjust this value appropriately depending on the sharpness of the picture.

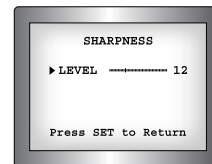

- PED LEVEL : Please use this menu item when using a LCD monitor other than standard ones. You can change PED LEVEL.
- RETURN : Select this to save the settings for the IMAGE ADJ. menu and to return to the SETUP menu.

Notes

- When the V-REV or H-REV mode is enabled, the text on the screen does not flip.
- If you increase the SHARPNESS level too high, the picture may become distorted or noise may appear.

Operating Your Camera

SPECIAL

1. When the SETUP menu screen is displayed, select 'SPECIAL' by using the Function Setup switch so that the arrow indicates 'SPECIAL'.

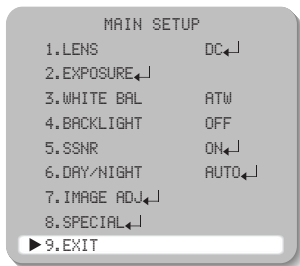

2. Select a desired mode using the Function Setup switch.



○ CAM TITLE : If you enter a title, the title will appear on the monitor.

- 1 If the SPECIAL menu screen is displayed, use the Function Setup switch so that the arrow indicates 'CAM TITLE'.
- 2 Set it to 'ON' by using the Function Setup switch.

Notes

- When the CAM TITLE menu is 'OFF', no title will be displayed on the monitor screen even if you enter one.
- Only English is available in this mode.

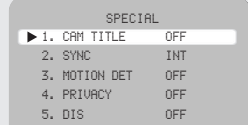

3 Press the Function Setup switch.

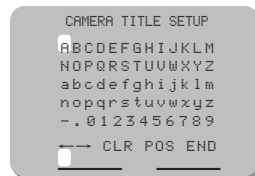

4 Use the Function Setup switch to move to a desired letter and select the letter by pressing the Function Setup switch. Repeat this to enter multiple letters. You can enter up to 15 letters.

Notes

- If you move the cursor to CLR and press the Function Setup switch, all the letters are deleted. To edit a letter, change the cursor to the bottom left arrow and press the Function Setup switch. Move the cursor over the letter to be edited, move the cursor to the letter to be inserted and then press the Function Setup switch.

5 Enter a title, move the cursor to 'POS' and press the Function Setup switch. The entered title appears on the screen. Select the position to display the title on the screen by using the Function Setup switch and press. When the position is determined, select 'END' and press the Function Setup switch to return to the SPECIAL menu.



Operating Your Camera

- **SYNC** : In areas where the supply is at 60Hz, you can synchronize the output phase of multiple cameras using the power synchronization function (Line-Lock) without using a synchronization signal generator.

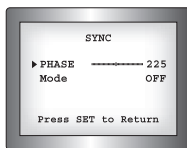

- INT : Internal Synchronization Type
- L/L : Power Synchronization Type, Line-lock
- Press the Function Setup switch.
- You can select a desired phase from 0 to 359 when select 'phase'.
- You can decide the synchronization between luminance and color signal when select the 'Mode' to TRACE.

Notes

- When using AC power at 60Hz frequency, you can use the L/L type synchronization.
- When the power is DC 12V, the SYNC menu is fixed to the 'INT' mode.

MOTION DET:

You can monitor activity more efficiently, because a signal is generated by the camera whenever motion is detected.

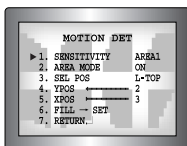

- 1 When the SPECIAL menu screen is displayed, press the Function Setup switch so that the arrow indicates 'MOTION DET'.
- 2 Set up the mode using the Function Setup switch.
 - SENSITIVITY : You can select up to 8 MD areas. When SENSITIVITY number is high, motion detection sensitivity is increased to recognize even small movement.
 - AREA MODE : Determines whether to use the MD area selected in SENSITIVITY.
 - SEL POS : Determines which of the 4 vertices of each MD area is to be used.
 - YPOS : Determines the coordinate of the vertical axis for SEL POS.
 - XPOS : Determines the coordinate of the horizontal axis for SEL POS.
 - FILL → SET : Fills in a selected MD area. Fills in a selected MD area. The color of filling is sequentially selected as brown, orange, blue, cyan, yellowish green, yellow and red.
 - RETURN : Select this to save the MOTION DET menu settings and return to the SPECIAL menu.

Notes

- MD areas show only MOTION DET menu. Therefore, MD areas don't display on the monitor screen.
- When motion is detected, "MOTION DETECTION" expression is displayed on the screen.

- **PRIVACY** : Hide an area you want to hide on the screen.



- 1 When the SPECIAL menu screen is displayed, press the Function Setup switch so that the arrow indicates 'PRIVACY'.
- 2 Set up the mode using the Function Setup switch.

- AREA SEL : You can select up to 8 PRIVACY areas.
- AREA MODE : Determines whether to use the area selected in the AREA SEL, and the size and position of the area.

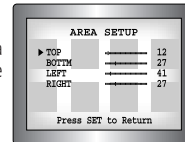

- MASK COLOR : Determine area color. You can select Gray, Green, Red, Blue, Black, White.
- TRANSP : Determine the transparency of selected area as controlling number from 0 to 3.
- RETURN : Select this to save the PRIVACY menu settings and return to the SPECIAL menu.

DIS (Digital Image Stabilizer) :

This function mitigates any picture movement due to external factors such as wind.

Notes

- The chance of resolution decrease is existed because DIS function uses the digital zoom.
- DIS doesn't operate when background illumination is too low.
- DIS doesn't operate when object pattern is monotonic as like sky or white wall.
- If DIS is enabled, the digital zoom is configured to less than 46 level.

COMM ADJ (Communication Adjustment) :

This function sets up the camera communication status when controlling the camera through an external control device.

- 1 When the SPECIAL menu screen is displayed, press the Function Setup switch so that the arrow indicates 'COMM ADJ'.
- 2 Set up the mode using the Function Setup switch.

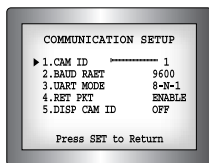

- CAM ID : Determines the camera's identification number (between 0 and 255).
- BAUD RATE : You can select 2400/4800/9600/19200/38400/57600 bps.
- UART MODE : You can select NONE, EVEN or ODD for the parity bits.
- RET PKT : Determines whether to send a command back to the controller device when a communication control command is sent to the camera.
- DISP CAM ID : Display camera title on top left corner of the screen.

* Initial value of communication adjustment

Item	Camera ID	BAUD RATE	UART MODE	PET PKT
Initial value	1	9600	8-NONE-1	ENABLE

- LANGUAGE : You can select the menu language according to your requirements.
- RESET : Resets the camera settings to the factory defaults.
- RETURN : Select this to save the SPECIAL menu settings and return to the MAIN SETUP menu.

EXIT

Press the Function Setup switch in the EXIT menu to save the current settings and exit the MAIN SETUP menu.

Refer to the following table if you are experiencing trouble with your camera. Contact an authorized technician if the table does not provide you with a solution to the trouble.

- **Nothing appears on the screen.**
 - ▶ Check that the power cord and line connection between the camera and monitor are fixed properly.
 - ▶ Check that you have properly connected VIDEO cable to the camera VIDEO output jack.
- **The image on the screen is dim.**
 - ▶ Is lens stained with dirt? Clean your lens with soft, clean cloth.
 - ▶ Set the monitor to proper condition.
 - ▶ If the camera is exposed to too strong light, change the camera position.
- **The image on the screen is dark.**
 - ▶ Adjust the contrast feature of the monitor.
 - ▶ If you have an intermediate device, set the 75Ω / Hi-Z properly.
- **The camera is not working properly, and the surface of the camera is hot.**
 - ▶ Check that you have properly connected the camera to an appropriate power source.
- **The DAY/NIGHT menu does not work.**
 - ▶ Check that AGC of EXPOSURE SETUP menu is 'OFF'.
- **The SENS-UP function does not work.**
 - ▶ Check that AGC of EXPOSURE SETUP menu is 'OFF'.
 - ▶ Check that SHUTTER of EXPOSURE SETUP menu is 'A,FLK'.
- **The Motion Detection function does not work.**
 - ▶ Check that MOTION DEF of SPECIAL SETUP menu is 'OFF'.
- **Color is not correct.**
 - ▶ Check the setting of WHITE BAL SETUP menu.
- **The screen flickers continually.**
 - ▶ Check that direction of camera turns toward the Sun.
- **RS-485 communication fails.**
 - ▶ Check the polarity between RS-485 Control Port and RS-485 cable.

485 Control Board Connection Port	RS-485 Control Port
(+) CONNECTION TERMINAL (TRX+)	485+
(-) CONNECTION TERMINAL (TRX-)	485-

- ▶ Check the RS-485 Communication establishment initial value

* RS-485 Communication establishment initial value

Item	Camera ID	BAUD RATE	UART MODE	RET PKT
Initial value	1	9600	8-NONE-1	ENABLE

- ▶ We recommend that you make ground connect between camera and controller in order to maintain safety communication control.

Specifications

		SVD-4600(W/N)	SVD-4600(W/P)
POWER	Input voltage	AC24V / DC12V	
	Power consumption	3.5W	
CCD	Size	Diagonal 6mm (1/3") Sony DS CCD	
	Total Pixels	811(H) x 508(V)	795(H) x 595(V)
	Effective Pixels	768(H) x 494(V)	752(H) x 582(V)
Sync	Scanning System	2:1 Interlace	
	Synchronization	Internal / Line Lock	
	Frequency	H : 15.734KHz / V : 59.94Hz	H : 15.625KHz / V : 50.00Hz
O.S.D		Korean, English, Japanese, French, Spanish, Portuguese	
		English, French, Germany, Spanish, Italy, Chinese, Portuguese	
E L E C T R I C A L	Back-light Compensation	WDR / HLC / BLC / OFF	
	Resolution	Color : 560 TV Lines ↑ BW : 700 TV Lines ↑	
	S/N (Y signal)	52 dB (AGC Off, Weight ON)	
	Min. Illumination	0.001 Lux (Color Sens-up), 0.00004 Lux (BW Sens-up) at F1.2	
	White Balance	ATW / AWC / Manual / Outdoor / Indoor (1800°K ~ 10,500°K)	
	Electronic Shutter Speed	Fixed (1/60 or Flickerless Mode) / Fixed (1/50 or Flickerless Mode)	
	Sens-up	AUTO / OFF (Selectable limit x2 ~ x256)	
	Gain Control	LOW/HIGH/OFF	
	SSNR	ON / OFF (1~32 Level)	
	Motion Detection	ON / OFF (8 Zone)	
	PRIVACY	ON / OFF (8 Zone)	
	V-REV (Mirror)	ON / OFF	
	H-REV (Flip)	ON / OFF	
	FREEZE	ON / OFF	
	SHARPNESS	ON / OFF (Level Adjustable)	
	IRIS Control	DC drive Lens	
	Day & Night	COLOR / Black & White / AUTO	
DIS	ON / OFF		
Digital Zoom	ON / OFF (x10)		
Communication	RS-485 (2400, 4800, 9600, 19200, 38400, 57600 bps selectable) (STW Protocol, Pelco-D Protocol available)		
Built-in Lens	x3.6 Vari-focal Lens (F1.2 f2.8~10.0mm)		
Angle of view	Horizontal	94.4° ~ 28°	
	Vertical	69.2° ~ 21°	
Monitoring angle	PAH	Manual 0° ~ 340°	
	TILT	Manual 0° ~ 146°	
Weather Proof	IP66		
Operating Temperature/Humidity	-10° to +50° / 30% to 80% RH		
Storage Temperature/Humidity	20° to +60° / 20% to 90% RH		
Dimension	Ø148 x 126 mm		
Weight	1.3kg		

* SVD-4600WN, SVD-4600WP : Ivory color base model

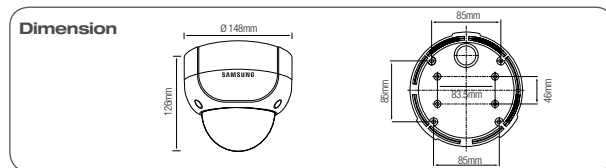

DECLARATION OF CONFORMITY

Application of Council Directive(s)	89 / 336 / EEC
Manufacturer's Name	SAMSUNG TECHWIN CO., LTD
Manufacturer's Address	SAMSUNG TECHWIN CO., LTD 42, SUNGJU-DONG CHANGWON-CITY, KYUNGNAM, KOREA, 641-716
European Representative Name	
European Representative Address	
Equipment Type/Environment	CCTV Camera
Model Name	SVD-4600P/WP
Beginning Serial NO.	S8080001
Year of Manufacture	2008. 12. 01
Conformance to	EN 50081-1 : 1992 EMC-Directive 89/336 EEC and 92/31/EEC EN 50130-4 : 1996

We, the undersigned, hereby declare that the equipment specified above conforms to the above Directive(s).

Manufacturer	SAMSUNG TECHWIN CO., LTD	Legal Representative in Europe
Signature	<i>Bong Jeng Gu</i>	Signature
Full Name	BONJENG GU	Full Name
Position	QUALITY CONTROL MANAGER	Position
Place	CHANGWON, KOREA	Place
Date	2008. 12. 01	Date

SAMSUNG TECHWIN

The Samsung logo, consisting of the word "SAMSUNG" in white, bold, uppercase letters inside a black, horizontally-oriented oval.

SALES NETWORK

• **SAMSUNG TECHWIN CO., LTD.**

145-3, Sangdaewon 1-dong, Jungwon-gu, Seongnam-si Gyeonggi-do, Korea, 462-703
TEL : +82-31-740-8151-8 FAX : +82-31-740-8145

• **SAMSUNG TECHWIN AMERICA Inc.**

1480 Charles Willard St, Carson, CA 90746, UNITED STATES
Tol Free : +1-877-213-1222 FAX : +1-310-632-2195
www.samsungcctvusa.com

• **SAMSUNG TECHWIN EUROPE CO., LTD.**

Samsung House, 1000 Hillswood Drive, Hillswood Business
Park Chertsey, Surrey, UNITED KINGDOM KT16 0PS
TEL : +44-1932-45-5300 FAX : +44-1932-45-5325

www.samsungtechwin.com
www.samsungcctv.com

P/No. : Z6806-0869-01C
VAN 09. 10